



# Changing Stations and Accessories Catalog





## Koala Kare: The Trusted Brand for Child Accommodation Products

## Safety, Durability and Innovation

For more than 35 years, Koala Kare Products has been the industry leader in commercial childcare accommodations. Our focus is to offer a wide range of well-designed, safe and durable changing stations that make it easier for families to enjoy a variety of public facilities.

### CONTENTS

3..... Accommodations and Compliance	12.....KB113-99 Diaper Kit, KB143-SS Stainless Diaper Dispenser
5 ..... KB300 Platform, 310-54 Stainless Steel Bag Hook	13.....KB160 Koala Pouch Disposal Bags, KB150-99 Sanitary Bed Liners
6 ..... KB310-SS Baby Changing Station	14-15 ..... Inclusion In the Restroom
7 ..... KB311-SS Baby Changing Station	16-17 ..... KB3000-Adult Changing Station
8 ..... KB300-SS & KB301-SS Baby Changing Stations	18-19 ..... Product Specs
9 ..... KB300 & KB301 Baby Changing Stations	20 ..... Maintenance and Warranty
10 ..... KB208 Surface-Mounted Baby Changing Station	
10..... KB112-01CT/KB112-01RE Countertop Changing Stations	
11..... KB102 Child Protection Seat	

# Thoughtful Accommodations for **All Families**

Koala Kare understands that accommodation in the restroom goes beyond just changing stations for small children. With an extensive portfolio that now includes an adjustable height changing station suitable for adolescents and adults, a child protection seat, and a dual-height floor-anchored retractable step stool, Koala Kare can help any restroom meet the needs of all families.



KB3000-AHL  
Adult Changing Station

## Compliance on Every Level

Products by Koala Kare comply with relevant industry standards, as well as local, state and federal legislation that pertain to our products. We are committed to operating in accordance with voluntary and mandatory standards throughout the United States and beyond. For questions regarding ASTM, ADA or EN standards, or TUV certification, contact [customerservice@koalabear.com](mailto:customerservice@koalabear.com) or 303.539.8300.



KB310-SSRE



KB301-01SS

# Needs Met: The KB300 Platform



# Whatever Your Restroom Needs Are, Koala Has the Solution.

The new KB300 platform of baby changing stations offers an array of models to meet any facility's needs for performance, fit and aesthetics.

We incorporated feedback from architects and end-users to develop product enhancements that improve durability, performance and visual appeal, such as:

- A variety of standard and custom colors and finishes
- Easy to use external stainless steel bag hook
- Microban® product protection
- Integral frame for enhanced strength

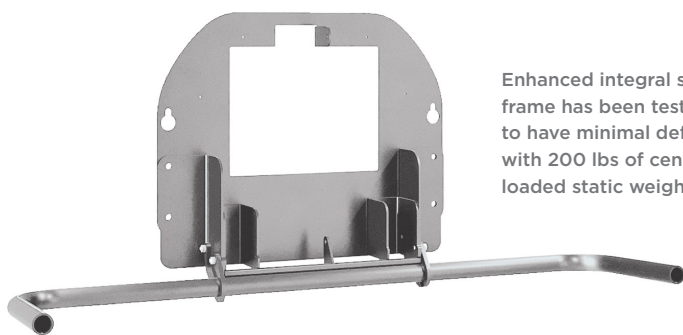

Enhanced integral steel frame has been tested to have minimal deflection with 200 lbs of center-loaded static weight.

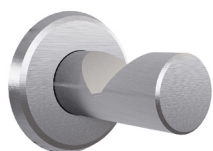

The 310-54 Stainless Steel Bag Hook safely stores diaper bags off the floor for easier access during changing.



KB311-SSRE



KB310-SSRE-MBLK



KB300-01SS



KB300-05

## KB310 Horizontal Baby Changing Stations — Stainless Steel



KB310-SSRE

### Our **Most Innovative** Baby Changing Stations Ever

Featuring a one-piece, deep-drawn, uniform grain stainless steel body that eliminates seams, sharp edges and weld lines, the KB310 horizontal and KB311 vertical stainless steel changing stations provide a modern visual aesthetic that matches other stainless steel restroom accessories. Design upgrades and amenities include Microban® product protection, a redesigned liner dispenser and a convenient external stainless steel bag hook for easier bag access during changing. Every version of the KB310 and KB311 is also available in a Matte Black finish. For very specific design needs, consult your Koala rep about custom colors and finishes.



# KB311 Vertical Baby Changing Stations — Stainless Steel



KB311-SSRE



KB311-SSRE — Opened Unit



KB311-SSRE-MBLK

Vertical KB311-SSRE and KB311-SSWM units feature a space-saving orientation for small or narrow restrooms.

Options	Horizontal	Vertical
Recessed-Mounted	KB310-SSRE	KB311-SSRE
	KB310-SSRE-MBLK	KB311-SSRE-MBLK
Surface-Mounted	KB310-SSWM	KB311-SSWM
	KB310-SSWM-MBLK	KB311-SSWM-MBLK

# KB300-SS and KB301-SS Surface-Mounted with Stainless Steel Veneer



KB300-01SS

## Design Solutions for High-end Restrooms

KB300-SS and KB301-SS plastic baby changing stations feature a stainless steel veneer that provides a high-end visual aesthetic and complements other stainless steel restroom accessories.

Options	Horizontal	Vertical
Grey	KB300-01SS	KB301-01SS
White Granite	KB300-05SS	KB301-05SS



KB301-05SS



# KB300 and KB301 Baby Changing Stations



KB300-00

## Quality and Durability for Demanding Environments

KB300 and KB301 plastic surface-mounted baby changing stations offer an affordable, easy-to-install option with an intelligent design and modern look. Available in a range of contemporary, neutral colors, the KB300 horizontal and KB301 vertical baby changing stations are a practical, eye-catching addition to any restroom.

Options	Horizontal	Vertical
Beige	KB300-00	KB301-00
Grey	KB300-01	KB301-01
White Granite	KB300-05	KB301-05



KB301-05

# KB208 Surface-Mounted Baby Changing Station

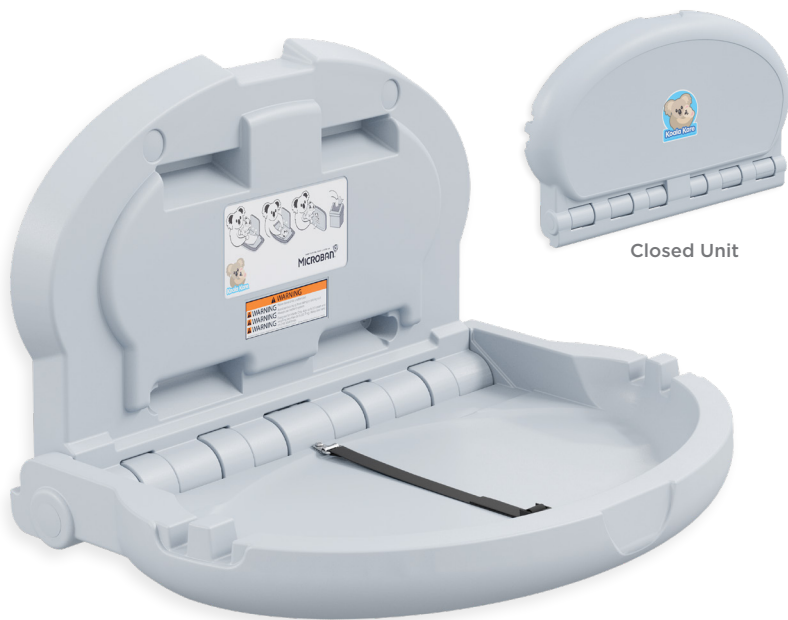

Visit [www.koalabear.com/KB208](http://www.koalabear.com/KB208) to learn more.

## Unique Design, Durable Construction

The KB208 is constructed of high-density polyethylene for greater exterior durability and features a steel pivot rod secured in a metal tube that offers sustained resistance to wear. It is ideal for restrooms with higher traffic and usage levels.

Grey	KB208-01
Sandstone	KB208-14

# KB112-01RE/KB112-01CT Countertop Changing Stations



## Defining the Diaper Changing Area on a Countertop

For restrooms that offer the countertop as the surface to change a diaper, this unit clearly defines that an area is designated only for diaper changing. Additionally, it provides a hygienic and safe surface to complete a diaper change.

Recessed	KB112-01RE
Countertop Mounted	KB112-01CT

# KB102 Child Protection Seat

## A Safe, Secure Wall-Mounted Seat

Koala Kare's child protection seat allows parents to comfortably secure a child while safely using the restroom themselves or tending to other matters in the restroom.

A steel pivot rod secured in an aluminum tube hinge mechanism provides superior support and wear resistance, while nylon safety straps that extend over child's shoulders and between legs safely secure the child.



Closed Unit

Cream	KB102-00
Grey	KB102-01

Visit [www.koalabear.com/KB102](http://www.koalabear.com/KB102) to learn more.





KB113-99 Diaper Kit

## Convenient Diaper Kits for Patrons

The Koala Kare Stainless Steel Diaper Dispenser comes in surface- or recessed-mounted versions. These units dispense onetime-use diaper kits containing a disposable diaper, bag, a Koala sanitary bed liner and two sanitary wipes.



KB143-SS Stainless Diaper Dispenser

# Koala Kare as Part of a Hygienic Restroom

Hygiene is crucial to a satisfactory user experience in the restroom. To complete and complement a proper changing station system, Koala Kare offers several accessory options to optimize the family experience and simplify your maintenance and hygiene routines.



## KB160 Koala Pouch Diaper Disposal Bags

The Diaper Pouch is a cartridge containing 175 diaper disposal sacks that easily fits into one of the liner dispensers of any KB200 or KB300 platform changing station. This helps get rid of unsightly used diapers and reduces odors by providing users a means to properly dispose of diapers.



Diaper Pouch Cartridge



## KB150-99 Sanitary Bed Liners

Koala Sanitary Bed Liners provide a disposable barrier between the baby changing surface and the child. These liners are made with 3-ply 50% recycled, biodegradable paper and are 100% recyclable. They come in a case of 500.



# Meeting the Changing Needs of Adults and Adolescents

For 35 years, Koala Kare Products has been the leader and innovator in commercial baby changing stations for public establishments. Now, we are introducing our first adjustable height changing station suitable for adolescents and adults, making it easier for all families to enjoy spending time together outside the home.

Too many families find themselves struggling to identify alternative solutions when an adequate changing station is unavailable. Without height-adjustable options, caregivers risk injuring themselves or their loved ones, which leads to many families choosing to stay home. This unit makes it easier for those with disabilities to participate in social activities in locations like amusement parks, museums, arenas, shopping malls and schools.



## Understand the Facts:

Approximately **30%** of the U.S. population has a disability

**65%** of families with disabled children feel isolated frequently or all the time

**83%** of disabled people have walked away from inaccessible or unwelcoming businesses

# KB3000-Adult Changing Station





# The Ultimate Combination of Performance and Contemporary Design

Koala Kare's first ever adjustable height changing station incorporates exceptional safety features, unmatched durability and careful considerations for the cared for and caregiver. This product is designed specifically for public spaces, emphasizing robust construction and enhanced durability.

The KB3000-AHL design includes a smooth surface that can be easily wiped down and disinfected. This vandal-resistant changing surface is rated to IK10, and its integrated recessed height controls are also designed to withstand tampering. The automatic height adjustment ranges from 12" to 41" from the floor.

Koala Kare's adjustable height changing station can safely support up to 500 lbs (227 kg) on the changing surface and is equipped with an emergency stop. The unit has a battery back-up in case of power outage to provide safe emergency lowering.

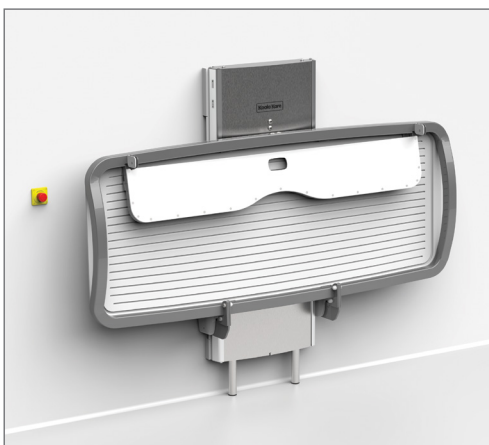

Flat-folding design maximizes space



Emergency stop button allows for complete control



Projects only 20" when closed

# Product Specs

## KB310-SSRE



**Unit Dimensions:**  
41 5/16" W x 26 7/32" H  
(1050 mm x 666 mm)

**Depth (closed):**  
2 23/32" (69 mm)

**Extension (open):**  
17 13/32" (442 mm)

**Shipping Weight:**  
80 lbs

### COLOR OPTIONS

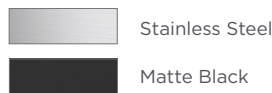

## KB310-SSWM



**Unit Dimensions:**  
43 3/4" W x 28 5/8" H  
(1111 mm x 727 mm)

**Depth (closed):**  
6 5/8" (168 mm)

**Extension (open):**  
21 5/16" (541 mm)

**Shipping Weight:**  
78 lbs

### COLOR OPTIONS



## KB311-SSRE



**Unit Dimensions:**  
26 7/32" W x 41 5/16" H  
(666 mm x 1050 mm)

**Depth (closed):**  
2 23/32" (69 mm)

**Extension (open):**  
32 27/32" (834 mm)

**Shipping Weight:**  
73 lbs

### COLOR OPTIONS



## KB311-SSWM



**Unit Dimensions:**  
28 5/8" W x 43 3/4" H  
(727 mm x 1111 mm)

**Depth (closed):**  
6 25/32" (168 mm)

**Extension (open):**  
32 27/32" (834 mm)

**Shipping Weight:**  
76 lbs

### COLOR OPTIONS



## KB300-SS



**Unit Dimensions:**  
35 15/16" x 20 3/4" H  
(912 mm x 527 mm)

**Depth (closed):**  
4" (101.6 mm)

**Extension (open):**  
21 3/16" (539 mm)

**Shipping Weight:**  
38 lbs

### COLOR OPTIONS



## KB301-SS



**Unit Dimensions:**  
20 3/4" x 35 7/8" H  
(527 mm x 911 mm)

**Depth (closed):**  
4" (101.6 mm)

**Extension (open):**  
36 5/8" (931 mm)

**Shipping Weight:**  
38 lbs

### COLOR OPTIONS

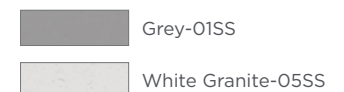



### KB300



**Unit Dimensions:**  
35 1/16" x 20 3/4"  
(912 mm x 527.5 mm)

**Depth (closed):**  
4" (101.6 mm)

**Extension (open):**  
21 3/16" (539 mm)

**Shipping Weight:**  
34 lbs

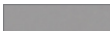
#### COLOR OPTIONS

-  Beige-00
-  Grey-01
-  White Granite-05



### KB301

**Unit Dimensions:**  
20 3/4" x 35 7/8"  
(527 mm x 911 mm)

**Depth (closed):**  
4" (101.6 mm)

**Extension (open):**  
36 5/8" (931 mm)

**Shipping Weight:**  
33 lbs

#### COLOR OPTIONS

-  Beige-00
-  Grey-01
-  White Granite-05



### KB3000-AHL

**Unit Dimensions:**  
75 5/16" x 60 15/32"  
(1913 mm x 1536 mm)

**Depth (closed):**  
9 23/32" (247 mm)

**Extension (open):**  
40 9/32" (1023 mm)



### KB208

**Unit Dimensions:**  
34" x 21"  
(864 mm x 533 mm)

**Depth (closed):**  
4" (101.6 mm)

**Extension (open):**  
21" (533 mm)

**Shipping Weight:**  
20 lbs

#### COLOR OPTIONS

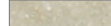
-  Grey-01
-  Sandstone-14

### KB112-01CT/ KB112-01RE

**Unit Dimensions:**  
36 1/2" x 22 5/8"  
(927 mm x 575 mm)/  
32" x 19 5/8"  
(812 mm x 498 mm)

**Depth:**  
3 1/4" (83 mm)/  
3 1/4" (83 mm)

**Shipping Weight:**  
8 lbs/6 lbs

#### COLOR OPTIONS

-  Grey Granite-01



### KB102

**Unit dimensions:**  
12 1/4" x 18 3/4" (311 mm x 476 mm)

**Shipping Weight:** 6 lbs

#### COLOR OPTIONS

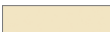
-  Cream-00
-  Grey-01



## Maintenance Matters

For a childcare product to last, it must have more than great design and quality craftsmanship; it must also be easy to maintain and keep clean. That's why Koala Kare is committed to helping you maintain a safe and hygienic restroom environment. We offer tools such as cleaning and maintenance checklists and easy to replace parts to help you keep your baby changing stations clean and in good working order.

## Cleaning

Baby Changing stations are often overlooked as part of routine cleaning and maintenance activities. To make sure users get the most of their changing experience, add any Koala products to your cleaning and inspection schedules. To make this easier, Koala offers cleaning/maintenance guides and checklists at [koalabear.com/maintenance-matters](http://koalabear.com/maintenance-matters).

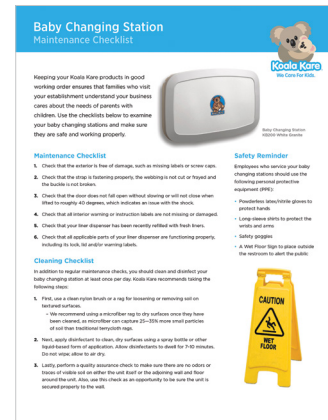

## Replacement Parts

To help you keep your Koala Kare products in good working order, we provide replacement parts for all our products. Be sure to regularly check replaceable parts, including shocks and straps, to make sure that they're functioning properly. To order replacement parts, simply visit the Replacement Parts homepage on our website, identify the baby changing station that you own and select the part that needs to be replaced. The new parts will be shipped directly to you. To learn more, visit [www.koalabear.com/replacement-parts-landing-page/replacement-parts/](http://www.koalabear.com/replacement-parts-landing-page/replacement-parts/)



**Koala Kare Products**  
6982 S. Quentin Street  
Centennial, CO 80112  
[Koalabear.com](http://Koalabear.com)

**Email:** [customerservice@koalabear.com](mailto:customerservice@koalabear.com)  
**Toll Free:** 888.733.3456  
**Outside the U.S.A.:** 1.303.539.8300  
**Fax:** 303.539.8399

## Warranty Information

Koala Kare warrants that baby changing stations will be free from defects in material and workmanship under normal use and service, with proper maintenance, for a period of five (5) years. The warranty for the KB3000-AHL station is for three (3) years. For additional warranty information, contact Koala Kare Products by visiting our website, [www.koalabear.com](http://www.koalabear.com)